







# User Interface Visotouch IC200 EVO FW 4.3

# INDEX

<b>1.</b>	<b>IMPORTANT RECOMMENDATIONS</b>	<b>3</b>
	SAFETY PRECAUTIONS	3
1.1	PRODUCT DISPOSAL (WEEE)	3
<b>2.</b>	<b>GENERAL WARNING</b>	<b>3</b>
2.1	 PLEASE READ BEFORE USING THIS MANUAL	3
2.2	 SAFETY PRECAUTIONS	3
<b>3.</b>	<b>INSTALLATION AND MOUNTING</b>	<b>4</b>
3.1	PANEL MOUNTING	4
3.2	WALL MOUNTING	4
<b>4.</b>	<b>ELECTRICAL CONNECTIONS</b>	<b>6</b>
4.1	PANEL VERSION	6
4.2	WALL VERSION	6
<b>5.</b>	<b>TECHNICAL DATA</b>	<b>7</b>
<b>6.</b>	<b>USER INTERFACE</b>	<b>7</b>

## 1. IMPORTANT RECOMMENDATIONS

-  Please read the general warning and the safety precautions before installing and using this product.
- This guide forms part of the product and must always be kept near the device for easy and quick reference.
- The device cannot be used as a safety device. Verify the limits of application before using the device.
- Dixell Srl reserves the right to change the composition of its products, even without notice, ensuring the same and unchanged functionality.

### SAFETY PRECAUTIONS

- The device must not be installed in particularly hot environments as high temperatures can damage it (electronic circuits and/or plastic components forming part of the casing). Comply with the temperature and humidity limits specified in the manual in order to store the product correctly.
- Disconnect all electrical connections before any kind of maintenance to avoid possible failure to the device and/or connected controller.
- Under no circumstances is the device to be opened; in case of failure or faulty operation send the instrument back to the distributor or to “Dixell S.r.l.” with a detailed description of the fault.
- Do not clean the device with corrosive chemical products, solvents or aggressive detergents.
- The device must not be used in applications that differ from that specified in the following guide.

#### 1.1 PRODUCT DISPOSAL (WEEE)

With reference to Directive 2002/96/EC of the European Parliament and of the Council of 27 January 2003 and to the relative national legislation, please note that:

- There lies the obligation not to dispose of electrical and electronic waste as municipal waste but to separate the waste.
- Public or private collection points must be used to dispose of the goods in accordance with local laws. Furthermore, at the end of the product's life, it is also possible to return this to the retailer when a new purchase is made.
- his equipment may contain hazardous substances. Improper use or incorrect disposal can have adverse effects on human health and the environment.
- The symbol shown on the product or the package indicates that the product has been placed on the market after 13 August 2005 and must be disposed of as separated waste.
- Should the product be disposed of incorrectly, sanctions may be applied as stipulated in applicable local regulations regarding waste disposal.

## 2. GENERAL WARNING

### 2.1 PLEASE READ BEFORE USING THIS MANUAL

- This manual is part of the product and should be kept near the instrument for easy and quick reference.
- The instrument shall not be used for purposes different from those described hereunder. It cannot be used as a safety device.
- Check the application limits before proceeding.
- Dixell Srl reserves the right to change the composition of its products, even without notice, ensuring the same and unchanged functionality.

### 2.2 SAFETY PRECAUTIONS

- Check the supply voltage is correct before connecting the instrument.
- Do not expose to water or moisture: use the controller only within the operating limits avoiding sudden temperature changes with high atmospheric humidity to prevent formation of condensation.
- Warning: disconnect all electrical connections before any kind of maintenance.
- The instrument must not be opened.

### 3. INSTALLATION AND MOUNTING

#### 3.1 PANEL MOUNTING

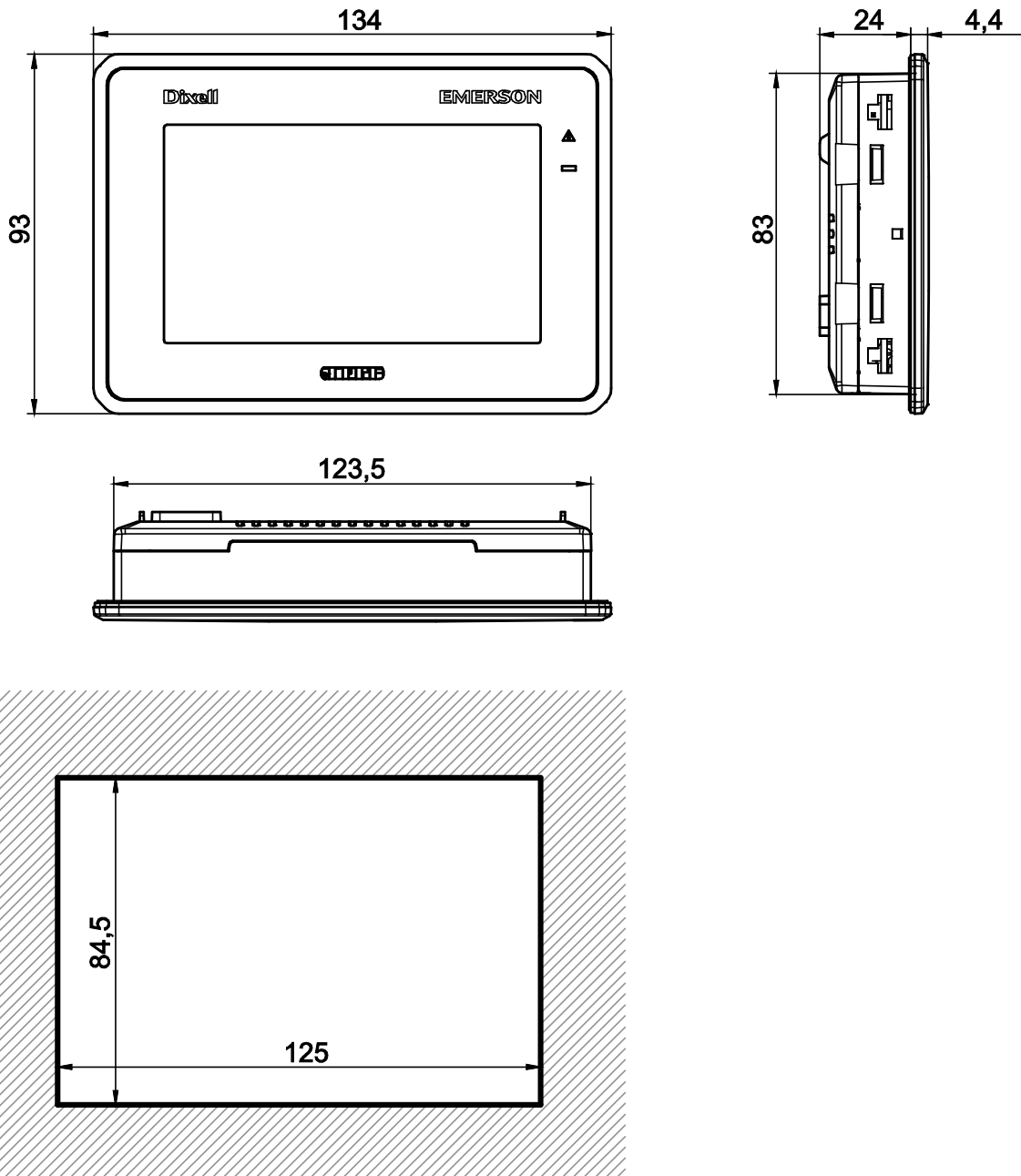

\* Size in mm

#### 3.2 WALL MOUNTING

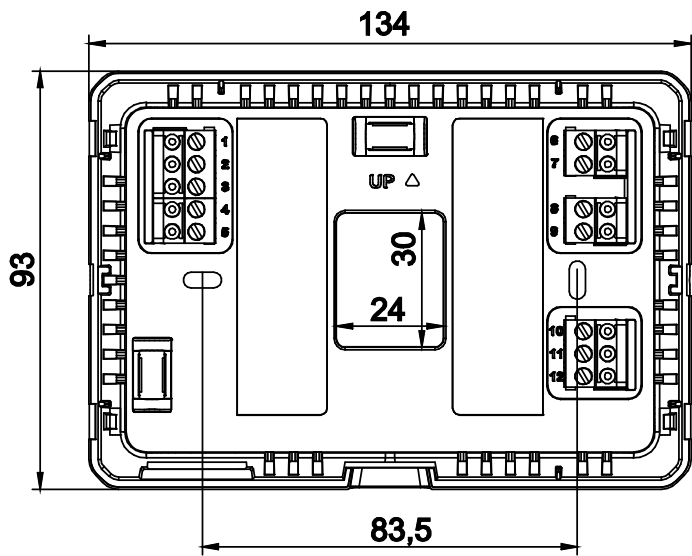
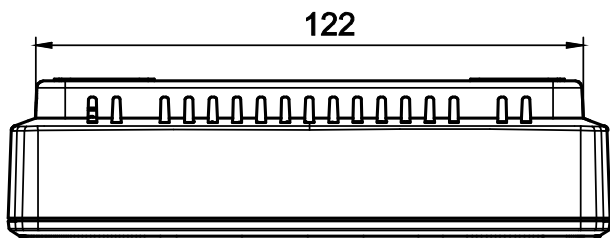
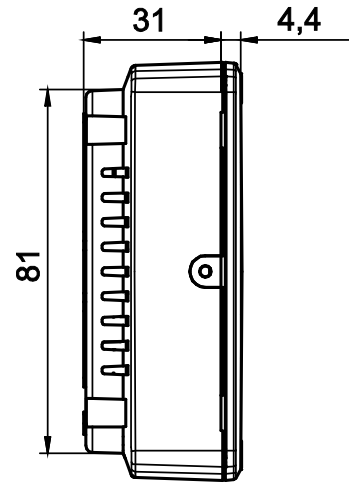
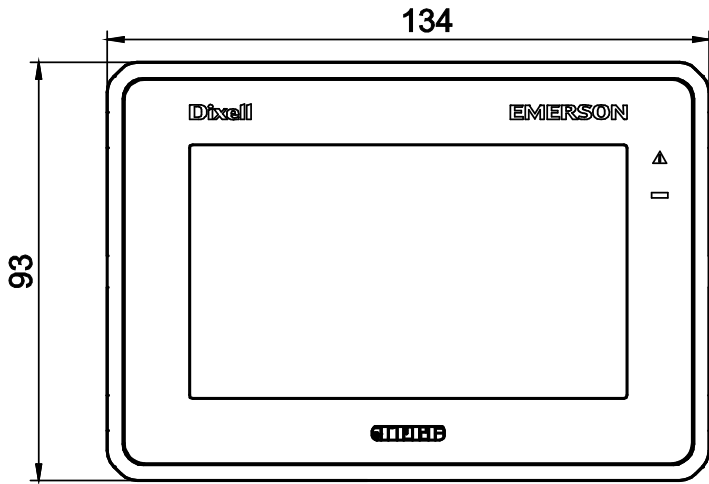

\* Size in mm

## 4. ELECTRICAL CONNECTIONS



Respect the connection polarity of the keyboard; a wrong connection can cause malfunctioning and possible damage to the controller or to the keyboard.

Using the external power supply it is necessary to separate the power of the device from the rest of the electrical devices connected inside the electrical panel. The secondary of the transformer must never be connected to the earth.

### 4.1 PANEL VERSION

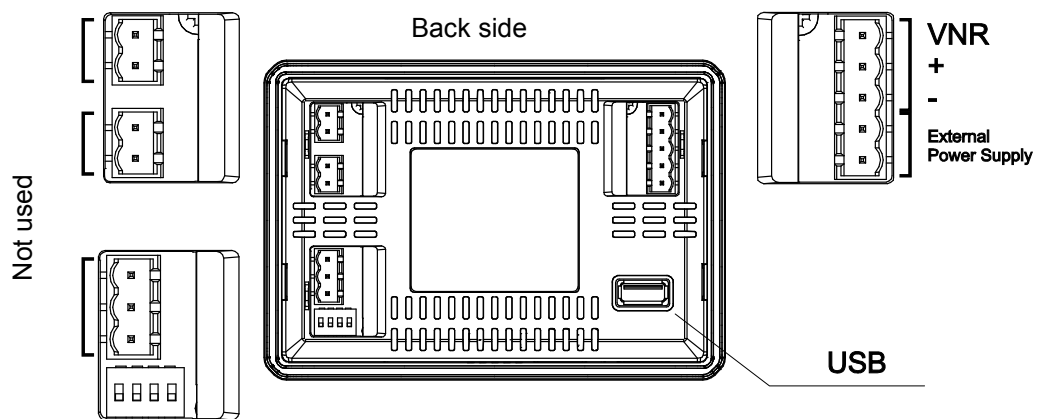

### 4.2 WALL VERSION

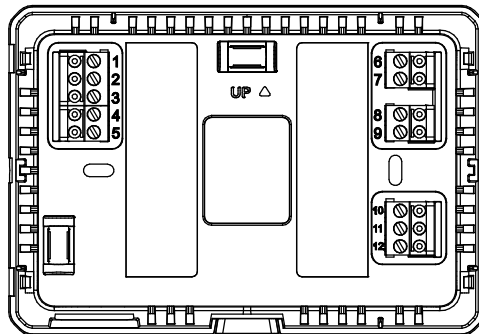

Terminals	Description
1	VNR for LAN connection
2	+ for LAN connection
3	- for LAN connection
4	External power supply
5	External power supply
6	Not used
7	Not used
8	Not used
9	Not used
10	Not used
11	Not used
12	Not used

## 5. TECHNICAL DATA

<b>Housing:</b>	Self are extinguishing ABS
<b>Mounting:</b>	Panel mounting Or wall mounting
<b>Frontal IP protection:</b>	IP20 with UR/NTC sensor IP54 without UR/NTC sensor
<b>Rear IP protection:</b>	IP20
<b>Connections:</b>	<b>Panel version:</b> STELVIO 90° screw connectors <b>Wall version:</b> wiring min 0.5 mm <sup>2</sup> – max 2.5 mm <sup>2</sup>
<b>Power supply:</b>	12-24 Vac/dc ±15%
<b>Power absorption:</b>	5W – 5VA
<b>Analogue input:</b>	NTC Dixell (-50T110°C; 10KΩ±1% at 25°C)
<b>Digital input:</b>	free of voltage
<b>Buzzer:</b>	Yes
<b>TFT:</b>	4.3"
<b>Resolution:</b>	480x272 px
<b>Colors:</b>	256 (8 bit)
<b>Touch:</b>	Resistive
<b>Measuring range:</b>	- 10÷50 °C (on-board NTC sensor) -50.0÷110 °C (remote NTC sensor) 20÷85% RH sensor
<b>NTC Resolution:</b>	0,1 °C
<b>Accuracy humidity sensor:</b>	±3% (20 to 80%) ±5% (elsewhere)
<b>Operating temperature:</b>	-20÷60 °C
<b>Storage temperature:</b>	-25÷70 °C
<b>Relative humidity:</b>	20÷85% (no condensing)

## 6. USER INTERFACE

Following the power on the Visotouch charges the installed application; if the operation is successful, the progress bar is displayed.

First user's operation is to select the language by clicking the desired language.

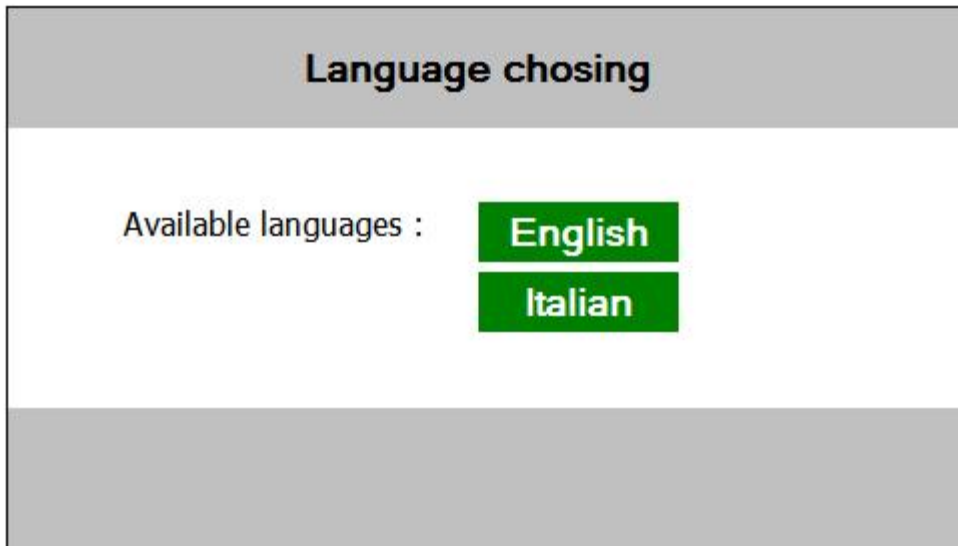





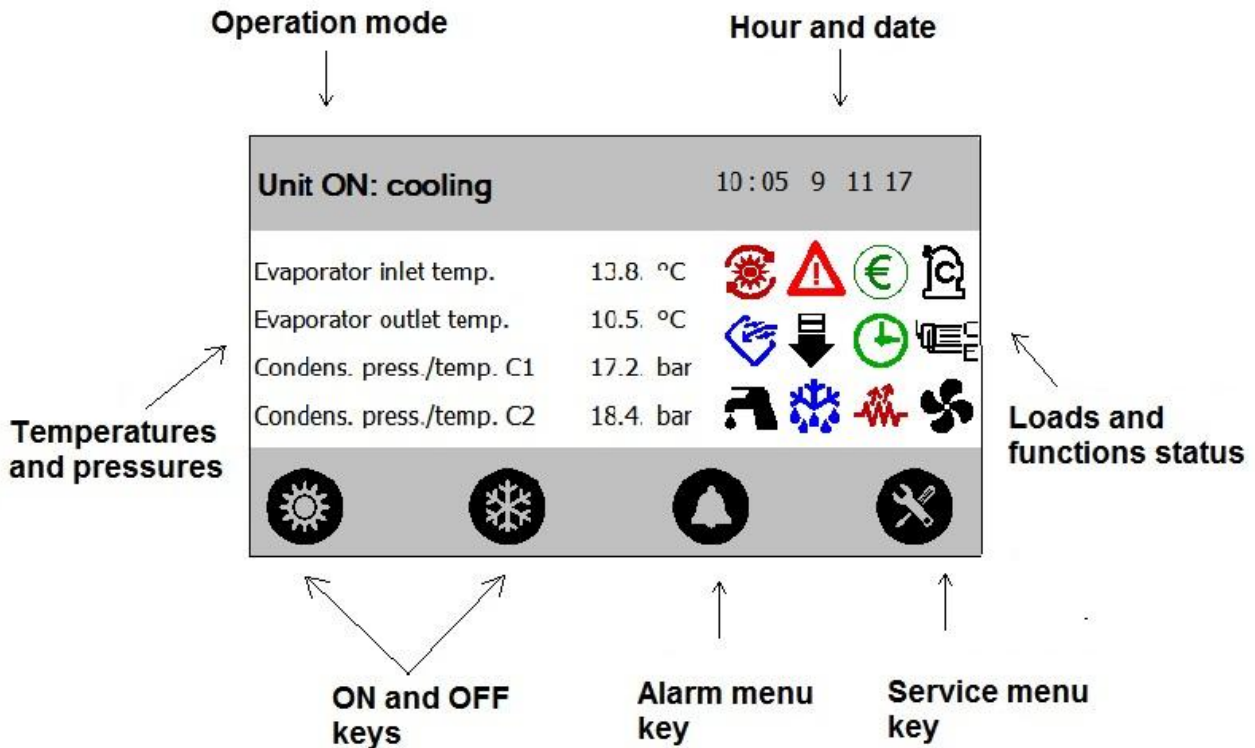





**Informations available on Main visualization screen:**

- Operation mode (STD-BY, or Remote OFF, or ON cooling, or ON heating)
- Hour and date (if the Ichill is provided by clock on board)
- Main temperatures or pressures (max. four probes selected by dP6..dP9 Ichill parameters)
- Main loads and functions status
- OFF key, cooling ON key, heating ON key, alarm menu key, service menu key



**Significato delle icone**

	On: at least a compressor is ON On blinking: at least a compressor is in timing of ignition
	On: at least a water pump is ON (E = evaporator, C = condenser)
	On: at least a condenser fan is ON
	On blinking: at least an alarm is on going
	On: unloading function is active
	On: at least a circuit is in defrost On blinking: at least a circuit is in timing of defrost
	On: at least a heater is ON
	On: at least an ON/OFF time band is enabled
	On: at least an Energy Saving time band is enabled
	On: domestic hot water production is on going

- **Service menu**



Pressing  key it is possible to:

- Read temperatures and pressures of configured probes
- Read and modify heating, cooling and domestic hot water set point
- Read circuit status (temperatures, pressures and compressors, water pumps, condenser fan status)
- Enter to **service** menu
- Enter to alarm menu

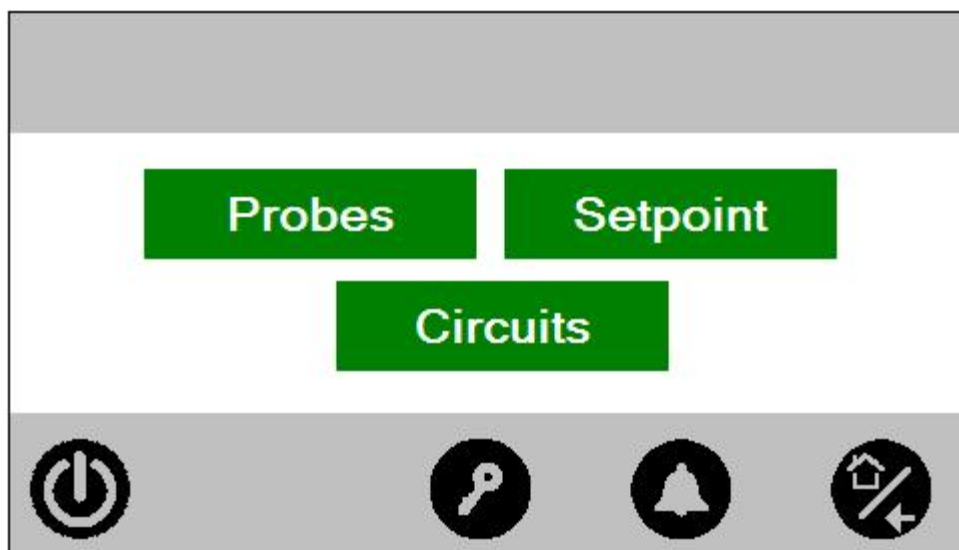

## Probes

- Probes menu

Probes menu allows to display the value of each probe connected to the IChill or I/O expansion; the selection is possible by clicking IChill probes or I/O expansion probes green button.

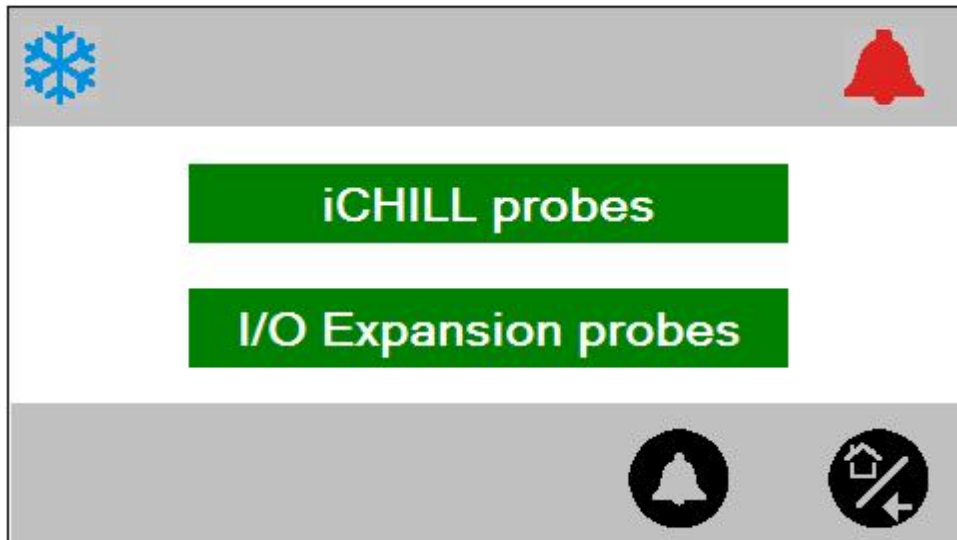

### IChill probes

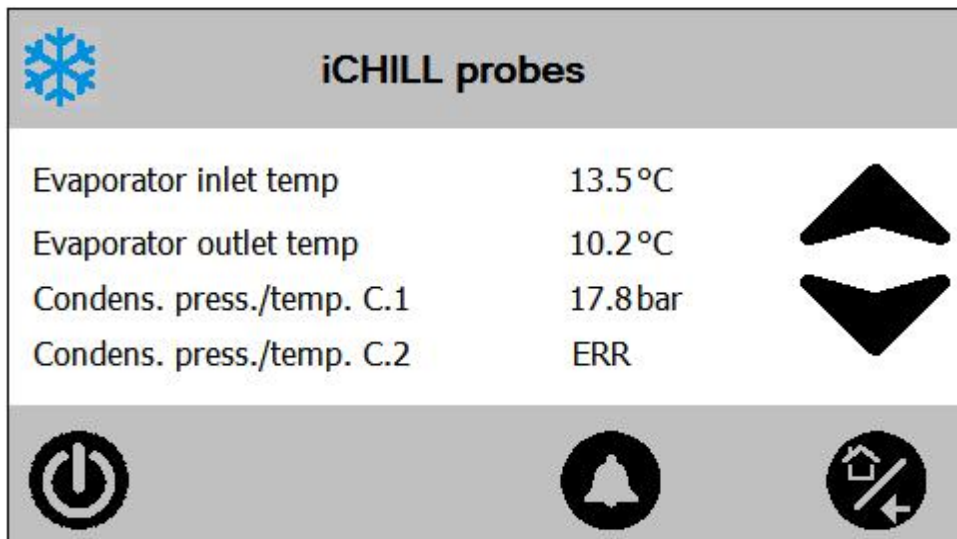

By clicking e key it is possible to read the value of all connected probes.

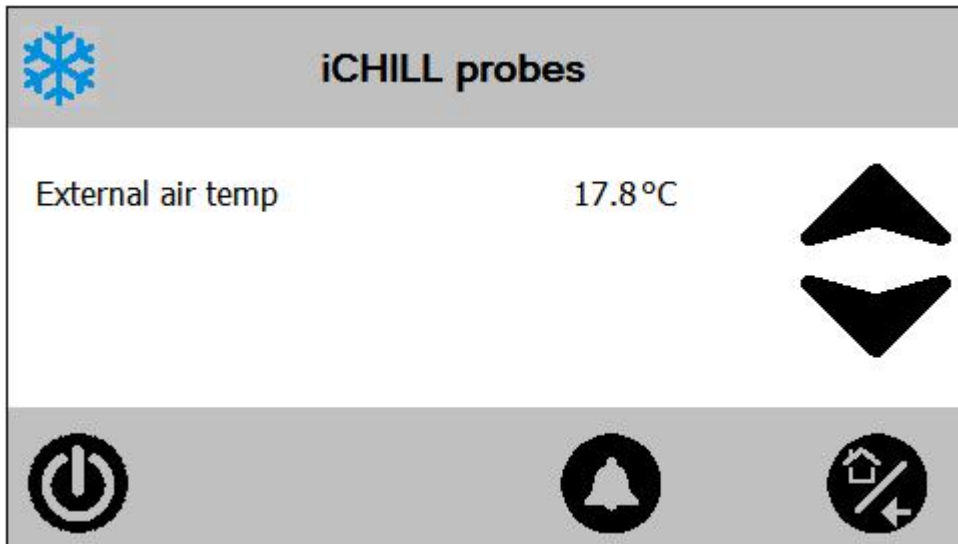

### I/O EXPANSION probes

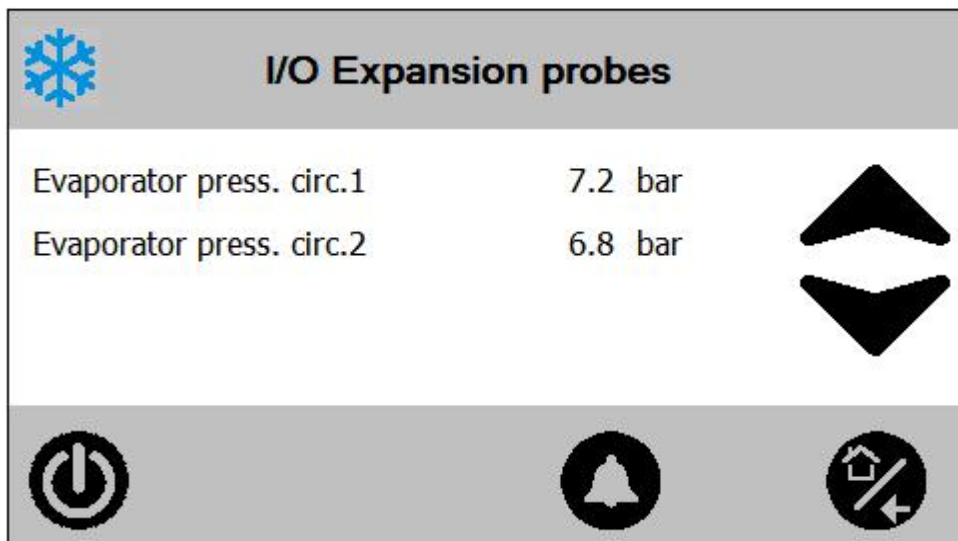

## Setpoint

- **SET POINT MENU**

SET POINT menu allows to read and modify heating, cooling and domestic hot water set point:

- If the IChill is ON in cooling, only cooling set point is visualized
- If the IChill is ON in heating, only heating set point is visualized
- If the IChill is in STD-BY or remote OFF, both heating and cooling set point are visualized

Moreover it is possible to read Energy Saving and Dynamic Set Point status, and Real set point if at least one of those functions is active.

Set point					
Cooling	10.0	°C	Energy saving	OFF	
Heating	40.0	°C	Dynamic set	OFF	
Sanitary water	50.0	°C	Actual set	10.0	°C
Recovery	45.0	°C			

+
Set
-
🔔
🏠 ↩

## Circuits

- CIRCUITS MENU**

CIRCUITS MENU allows to display main circuit resources status (probes value, compressors status, fan status, etc.).

If screw, or with capacity step, or inverter controlled compressors are configured, the output percentage is visualized.

Clicking on ▲ or ▼ key it is possible to visualize all available informations.

### Compressor status



Compressors status						
Circuit 1	1	2	3	4	5	6
	Unloading ON	100%	100%	100%	100%	
Circuit 2	2	2	2	2	2	▼
	Unloading ON	100%	100%	100%		

🔌
🔔
🏠 ↩

### Evaporating and condensing probes



 **Evaporating-condensing probe**



	High press.	Low press.	
<b>Circuit 1</b>	17.5 bar	N.C.	
<b>Circuit 2</b>	18.7 bar	N.C.	

Evaporator water pump status

 **Evaporator pump status**

Evap. pump 1	Evap. pump 2	
	Not configured	

Condenser water pump status

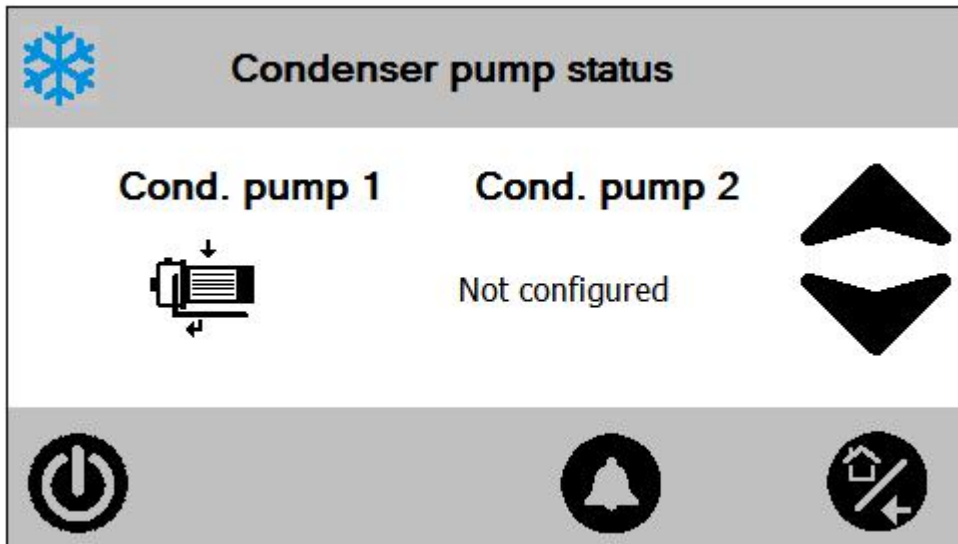

Supply fan status (only air to air unit)

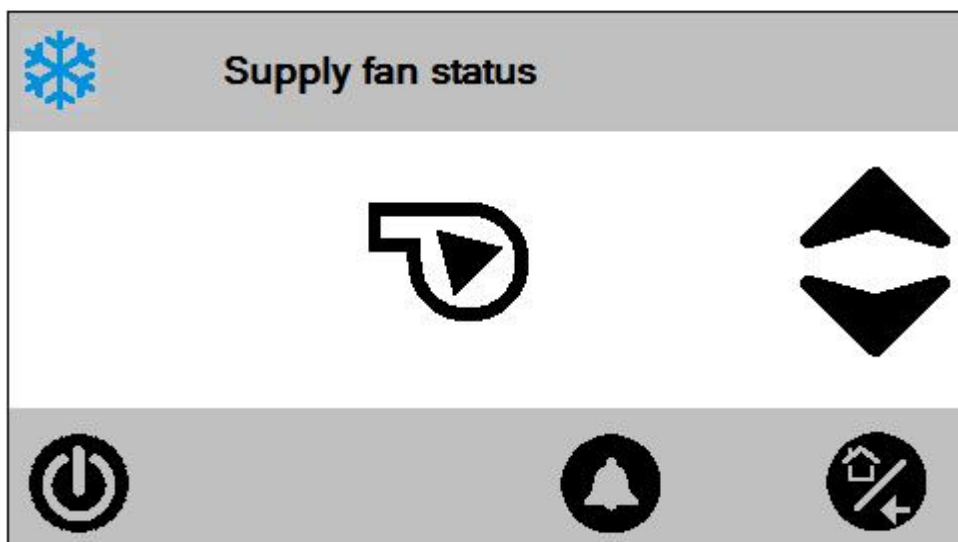

Modulating condenser fan

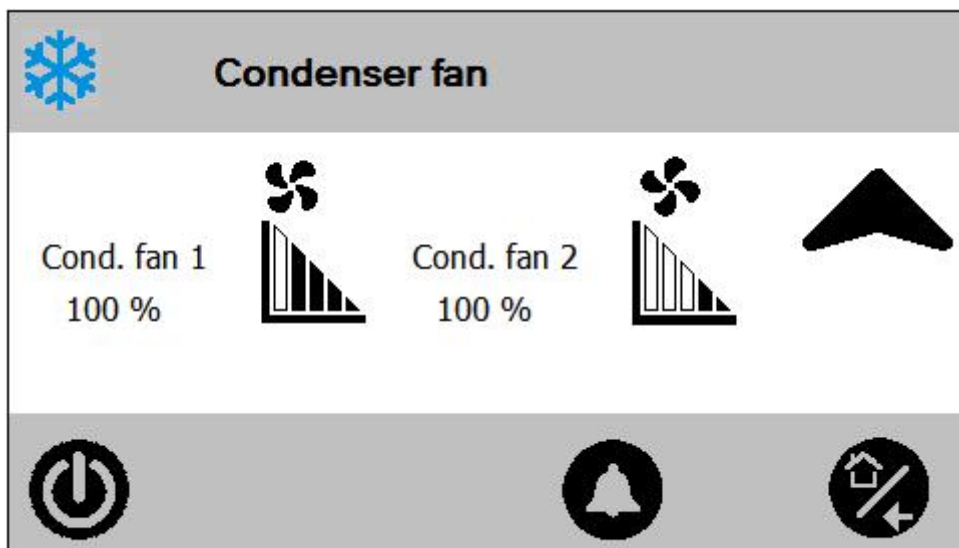

Condensing fan by power steps

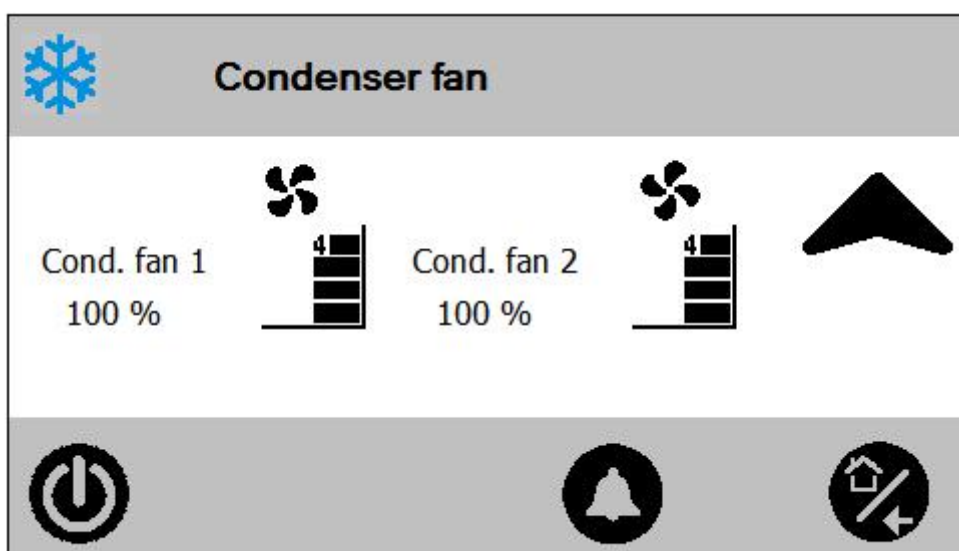

• **ALARMS MENU**  and 

Alarm menu allows to display and reset on going alarms.

Alarm status can be:

- Active: the alarm is on going and it can't be reset
- Reset: the condition that has produced the alarm is not present and the alarm can be reset manually
- Password: the condition that has produced the alarm is not present and the alarm can be reset manually, typing the password.

How to reset an alarm protected by password:

- Tap on Password button
- Tap ENTER button
- Use + and – to type the password value
- Tap ENTER button

- If the password is correct, “Password OK! Alarm not present” message is visualized

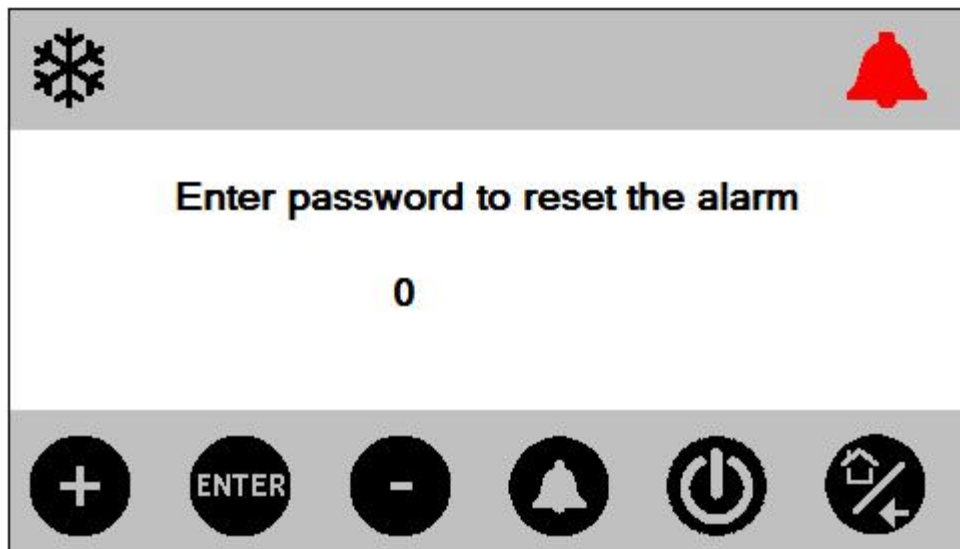
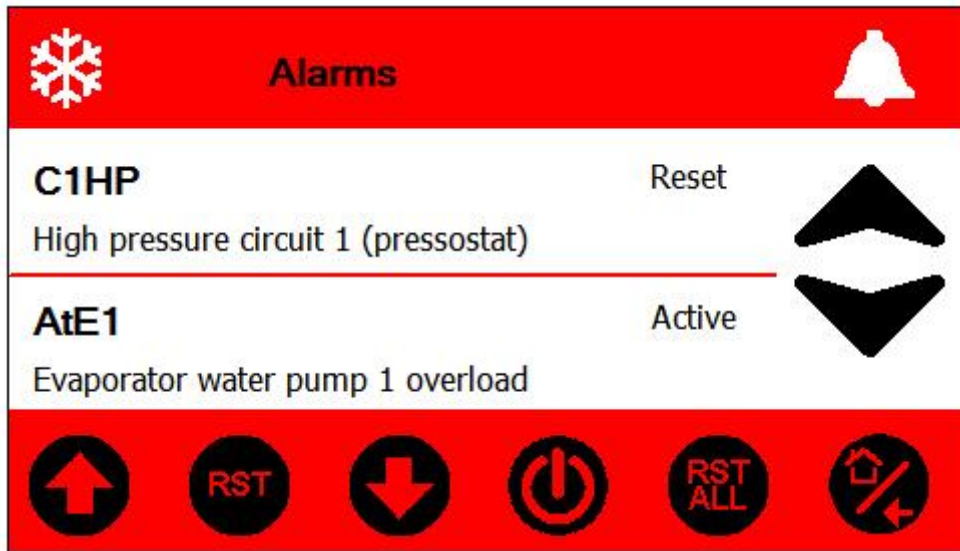

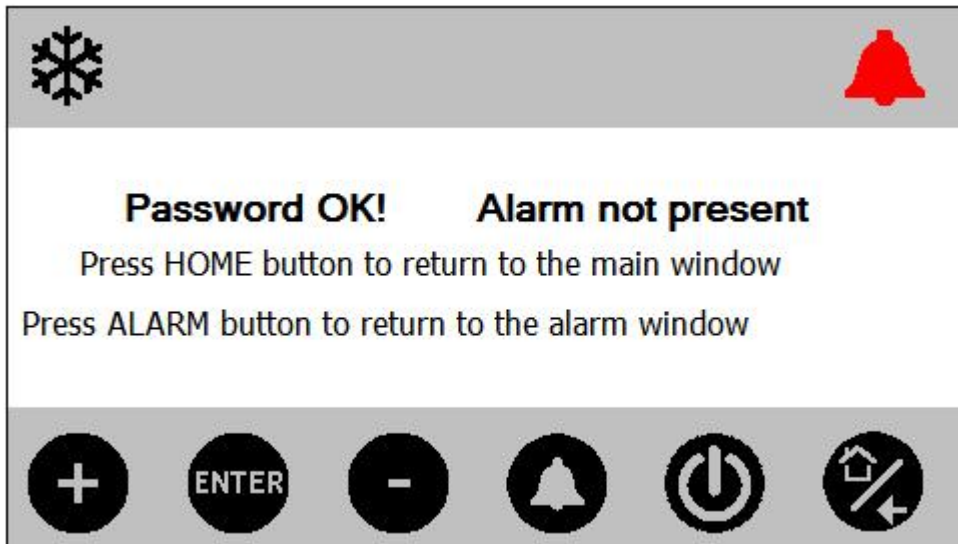

The Ichill can be configured for asking a password to enter to ALARMS menu; the procedure is the following:

- Tap  key
- Tap ENTER button
- Use + and – to type the password value
- Tap ENTER button
- If the password is correct, “Password OK! Press ENTER to continue” message is showed

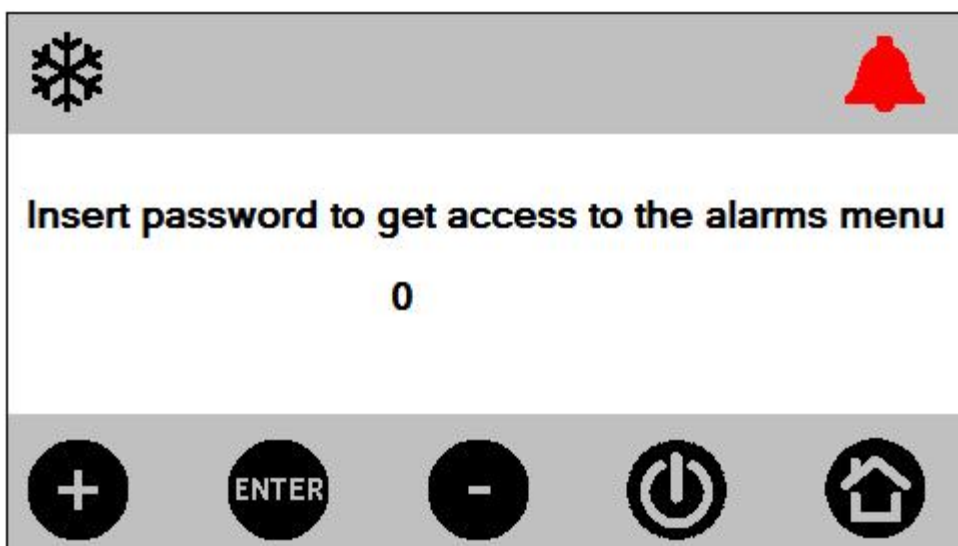

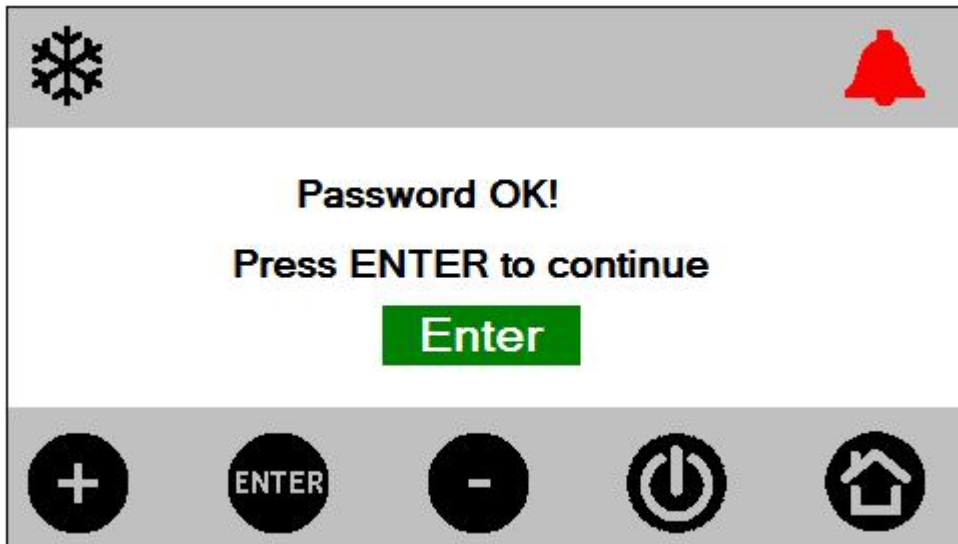

- **SERVICE menu**

After entering to SERVICE menu, Level 1 is available; at this level only high level information are available.

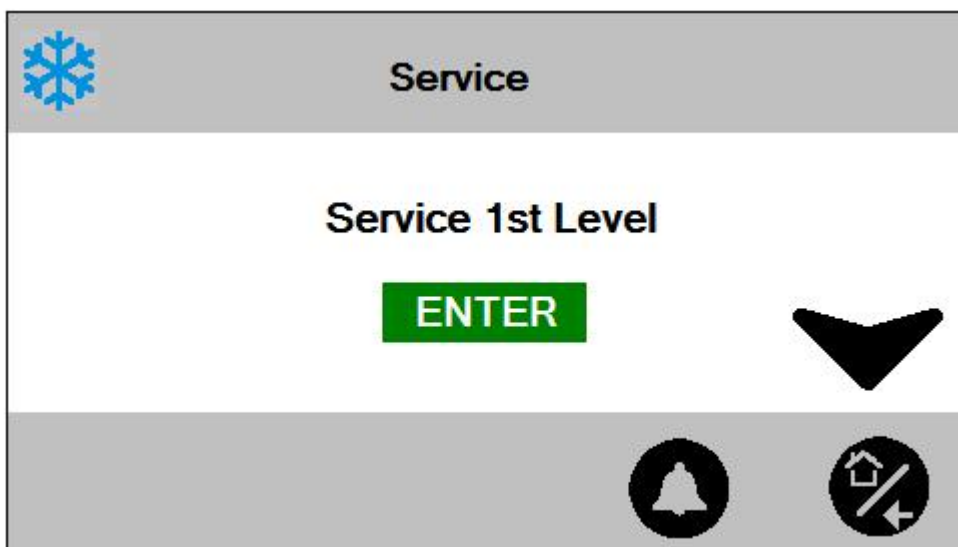

Service level 2 or level 3 are selectable pressing  key.

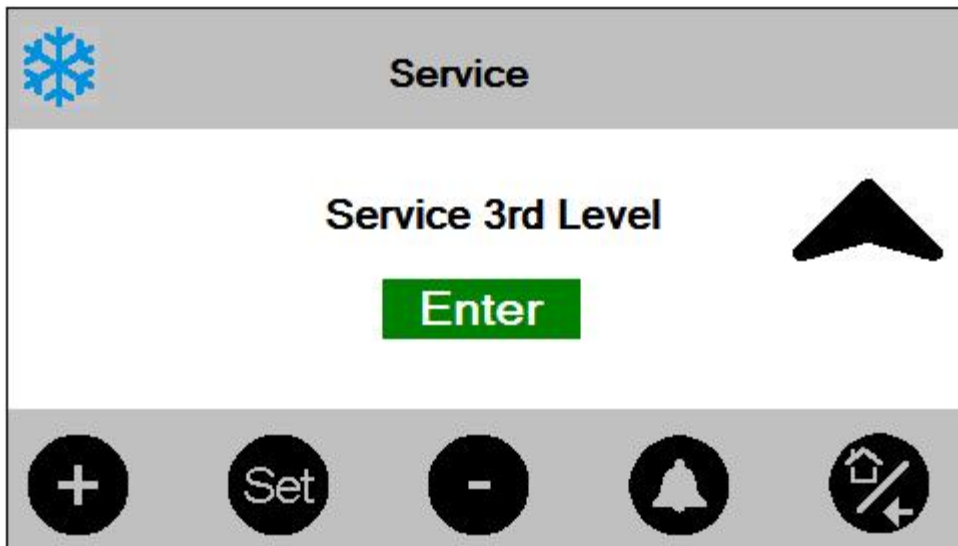
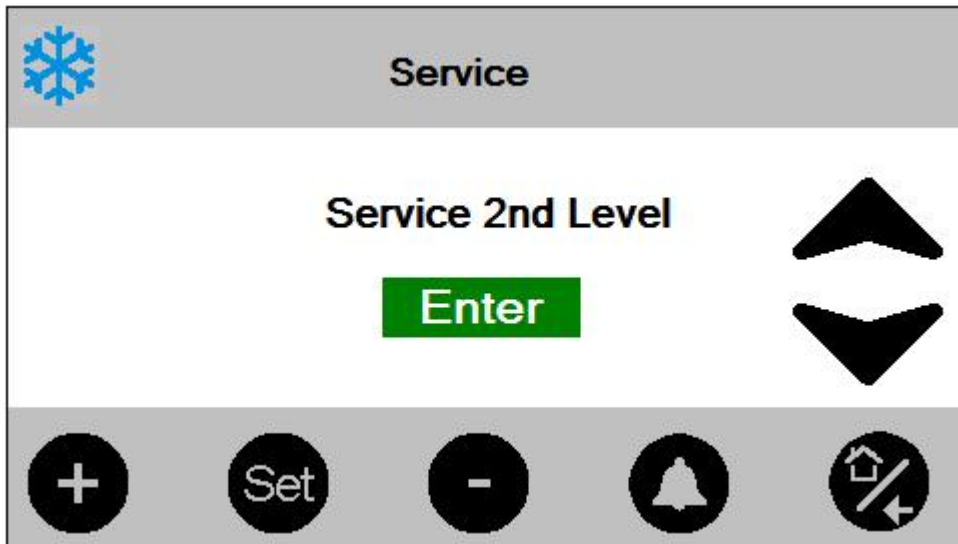

To enter to level 2 and level 3 is necessary to insert the respective password:

- Tap Set button
- Use + and – to type the password value
- Tap Set button

If the password is correct it is possible to enter to Service level pressing .

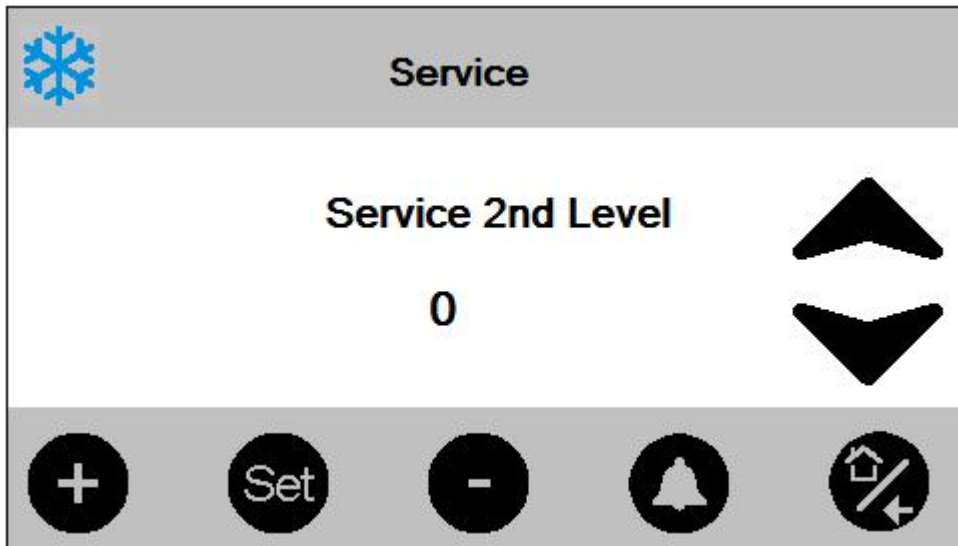

### Service level 1

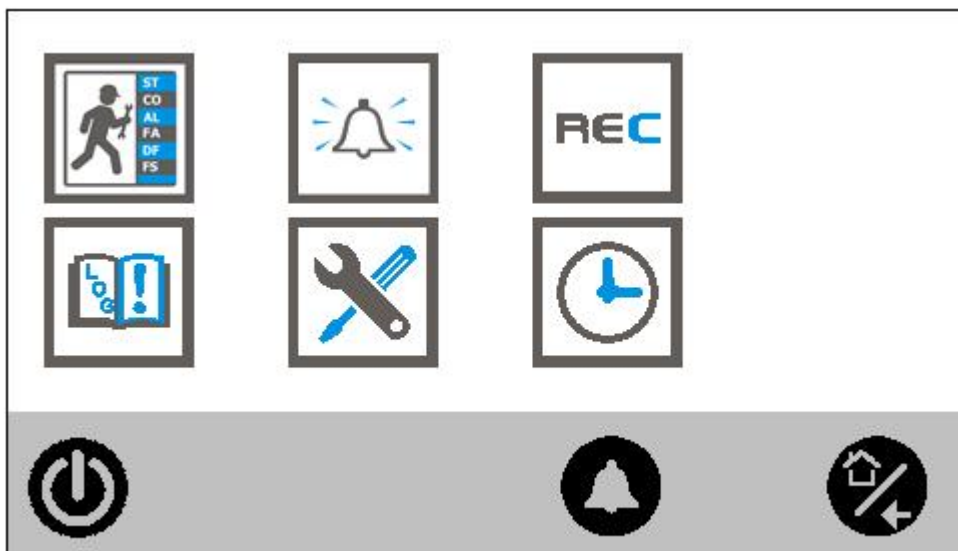

### Service level 2 and level 3

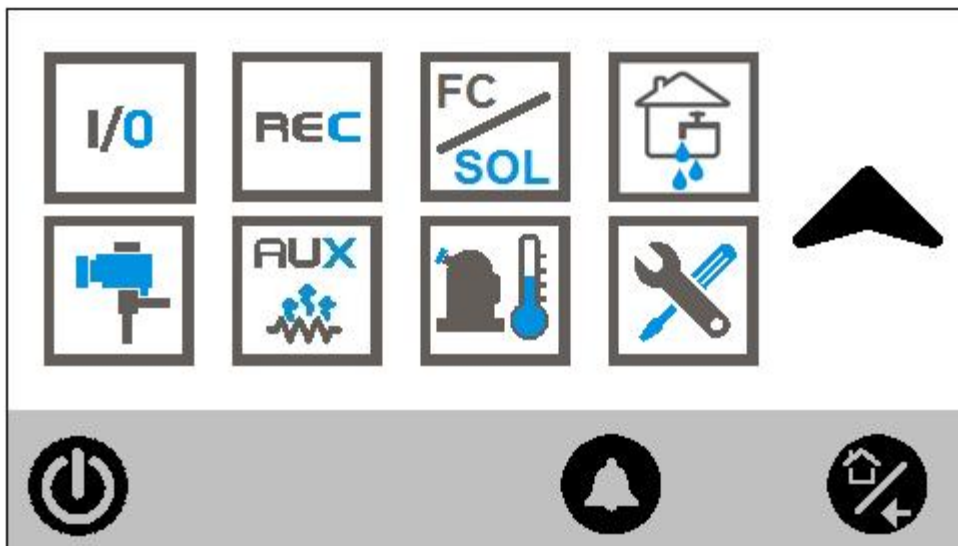

- **PARAMETER MENU**  The selection of the parameters visible on each service level (Service level 2 or Service level 3) is determined by the parameters map of the IChill.

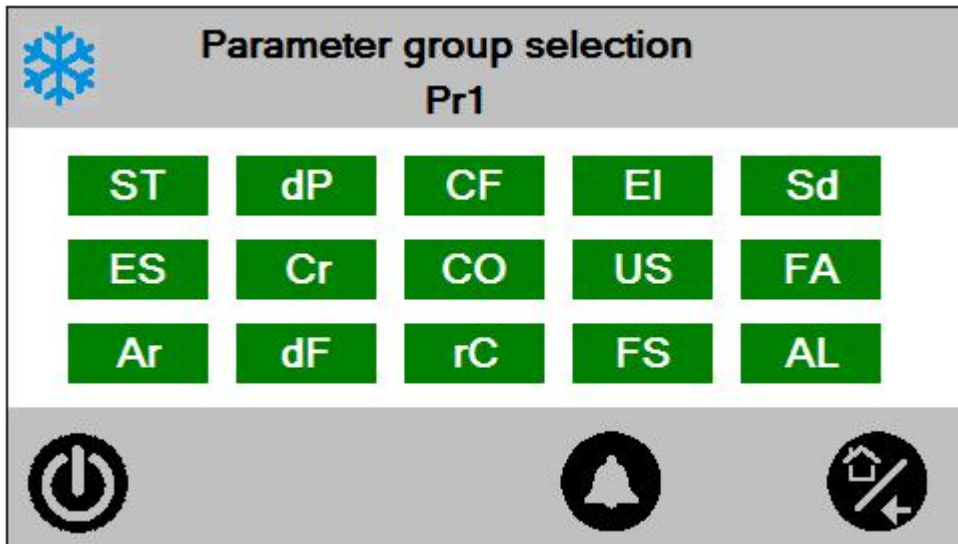

Tapping directly on a group of parameters, the parameters contained in this group are displayed.

How to modify a parameter:

- Tap directly on the value to modify
- Tap Set key
- Use + and – to type the password value
- Tap Set button

If the parameter is not modifiable, it means that it is only reading.

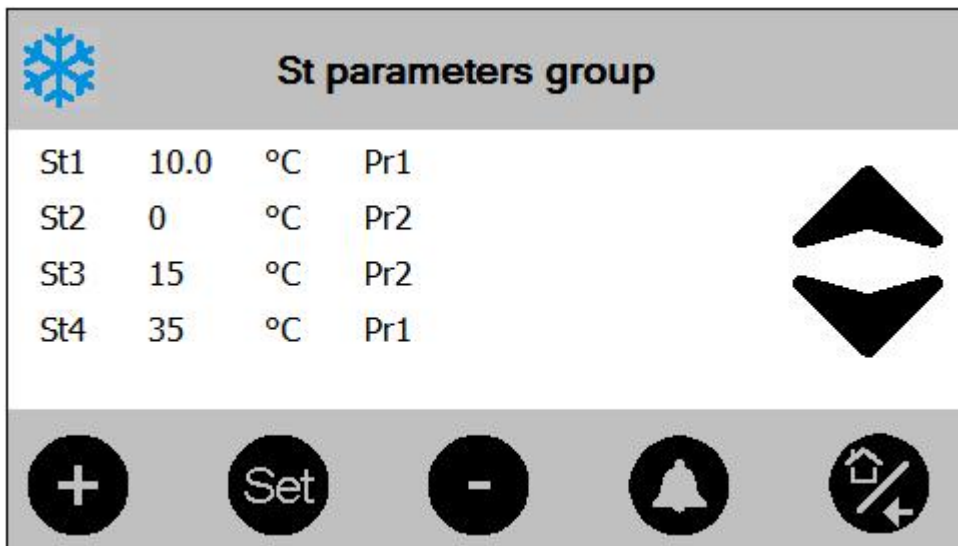

○ **CLOCK menu**



Clock menu is available only if the Ichill is provided by clock on board. It is possible to set the clock and the time band of Energy Saving and ON/OFF function.

Clock setting:

- Tap directly on the data to set (hour, minutes, day, etc.)
- Tap Set button
- Use + and – to change the value
- Tap Set button



### Set up time / hour / time bands





Time set up	10 : 19	
Date set up	05 / 10 / 2016	
Day of week	Sunday	
Energy saving	enabled	
Auto power off	disabled	

    



### Set up time / hour / time bands

	Start	Stop	
Time band 1:	08:00	12:00	
Time band 2:	15:00	17:00	
Time band 3:	00:00	00:00	

    

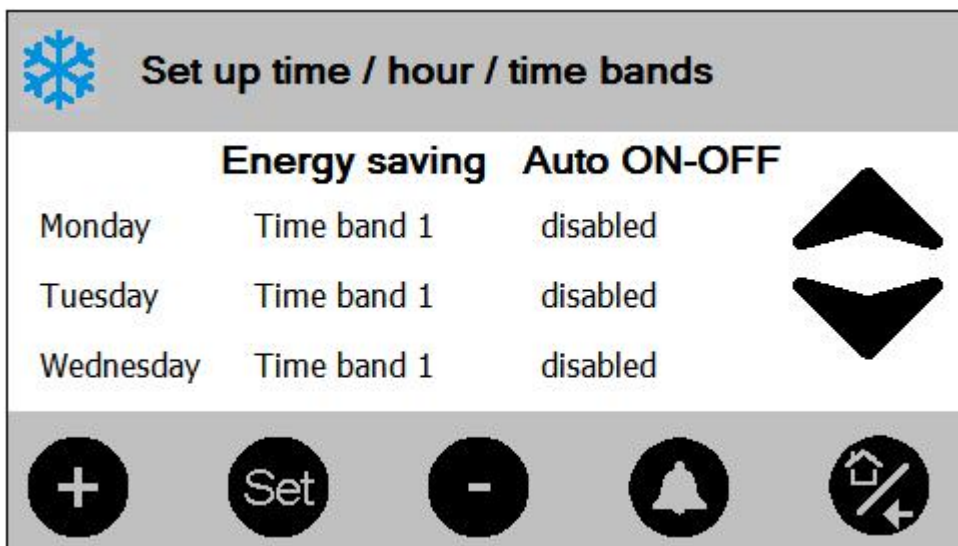

- **COMPRESSOR** menu (not visible to Service level 1)



Compressor menu allows to display and reset compressor working hour and start-up.

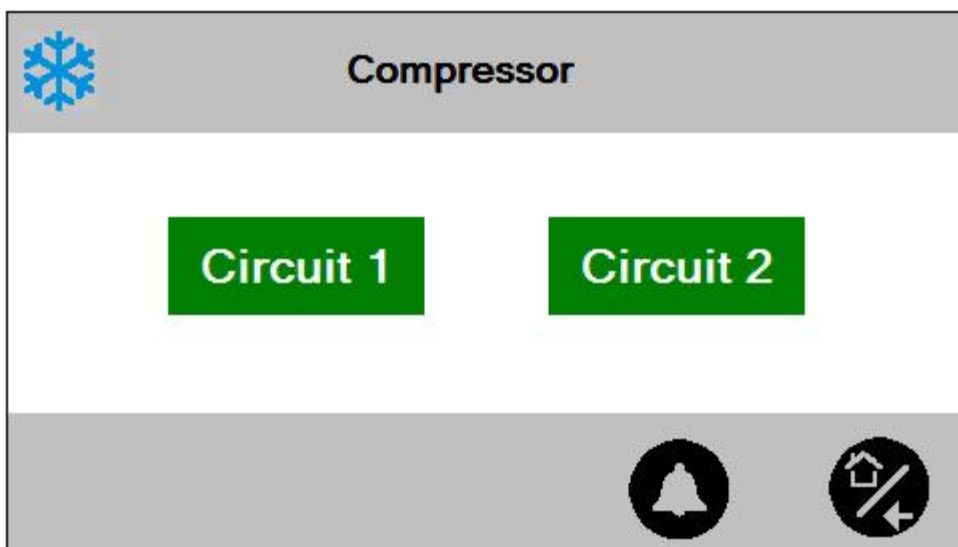

Circuit 1				
	Hour	Start-up	Status	
Compressor 1	954 <b>RST</b>	2870 <b>RST</b>	enabled	
Compressor 2	869 <b>RST</b>	2566 <b>RST</b>	enabled	







How to reset compressor working hours and start-up:

- Tap directly on RST label alongside of the data to reset (working hours or start-up)
- Tap Enter button
- Use + and – to change the value
- Tap ENTER button



**Insert password for hours reset**

0



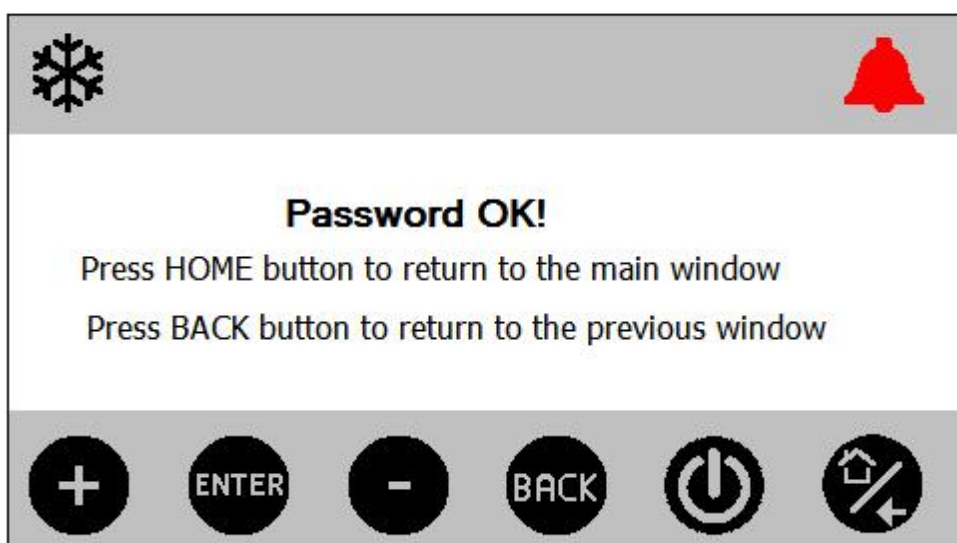
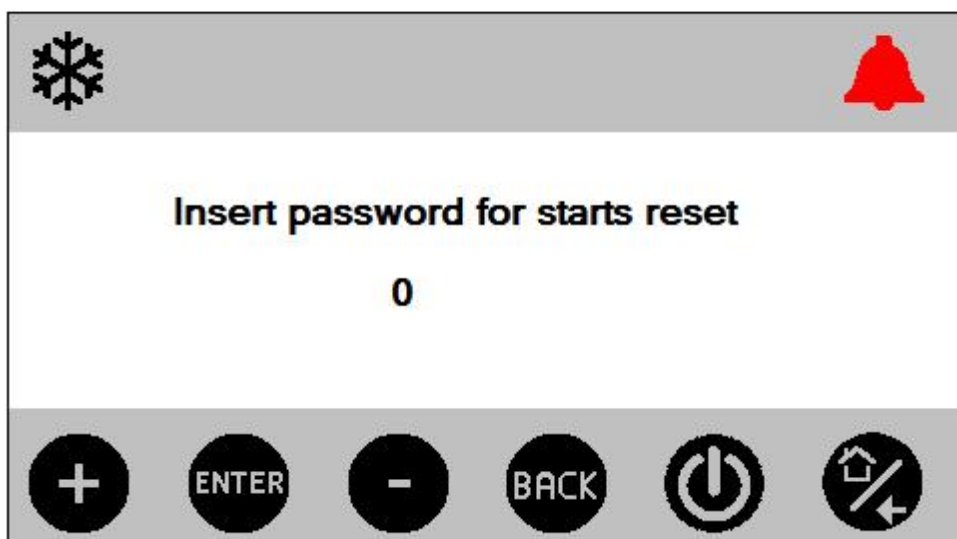
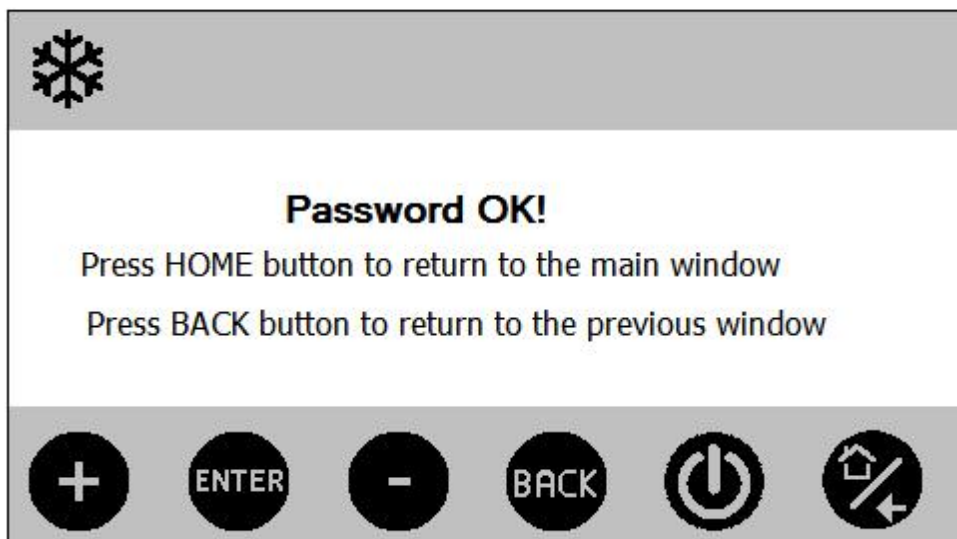

○ **WATER PUMP / SUPPLY FAN menu**

Water pump / Supply fan menu allows to display and reset working hours.

How to reset working hours:

- Tap directly on RST label alongside of the data to reset
- Tap ENTER button
- Use + and – to type the password value
- Tap ENTER button

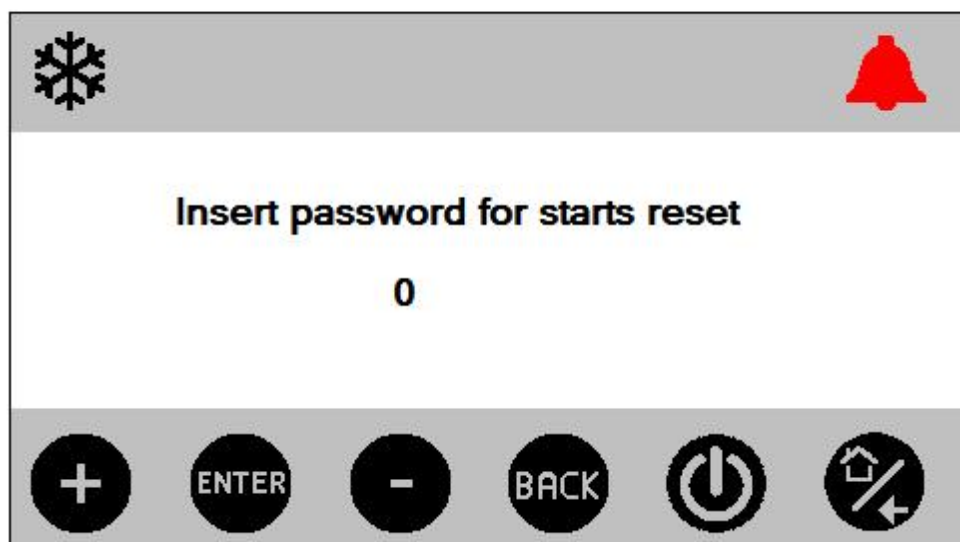
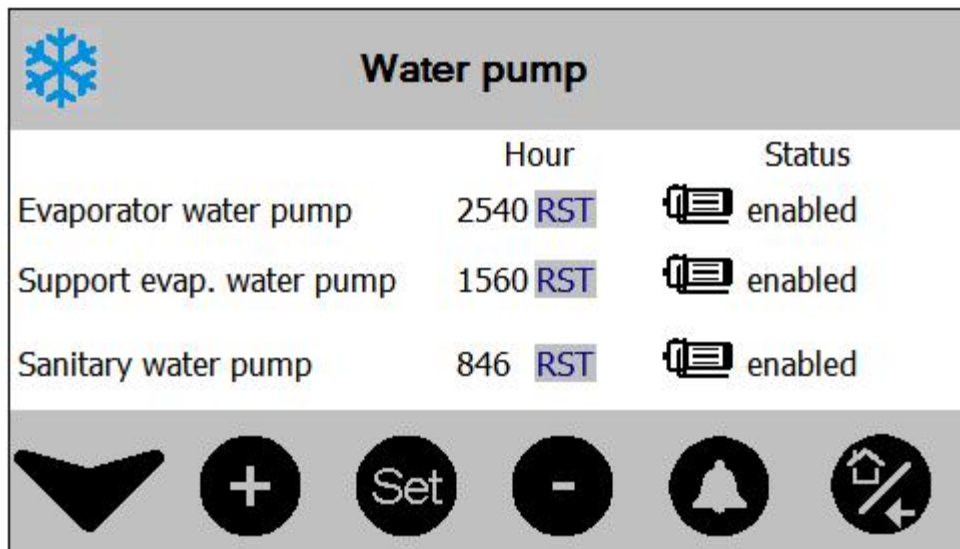

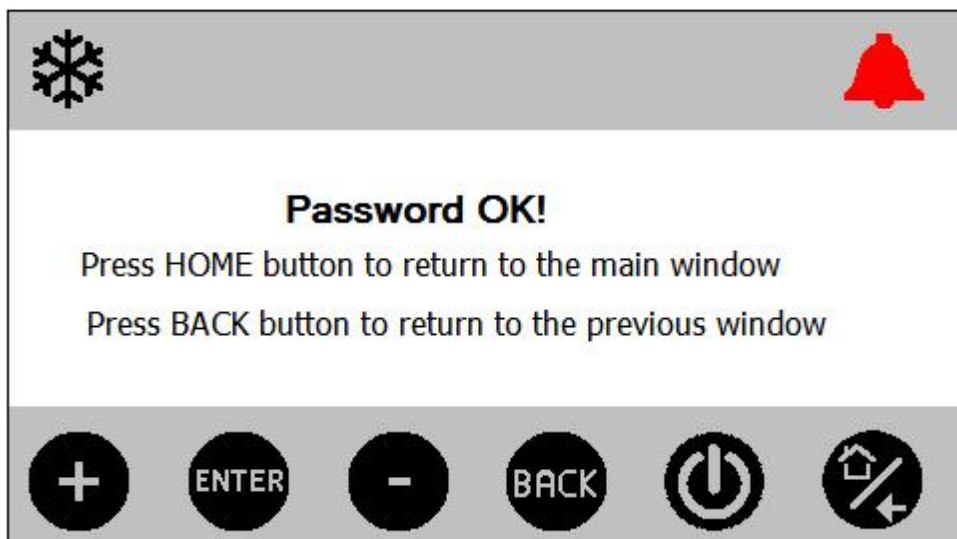

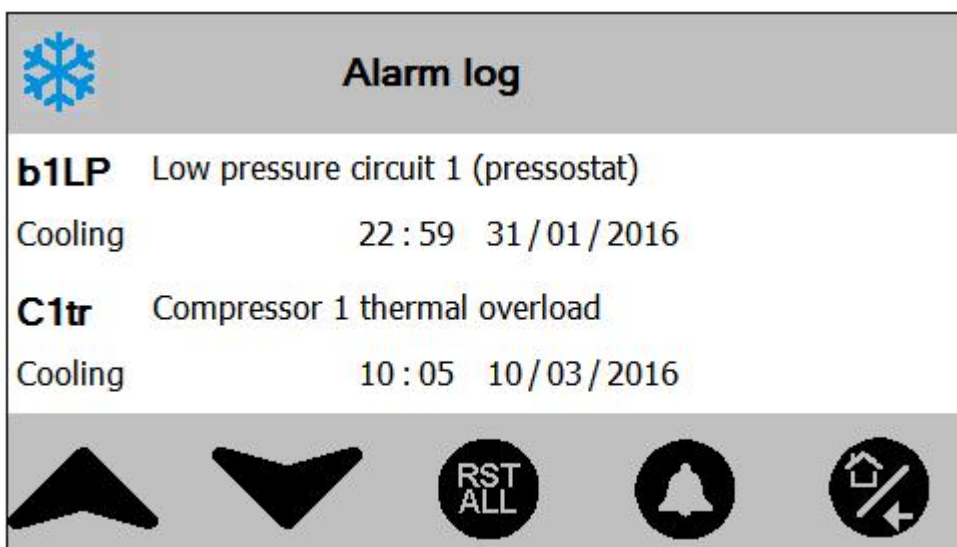

- **ALARM LOG menu**  Alarm log menu allows to display and reset the list of last alarms.

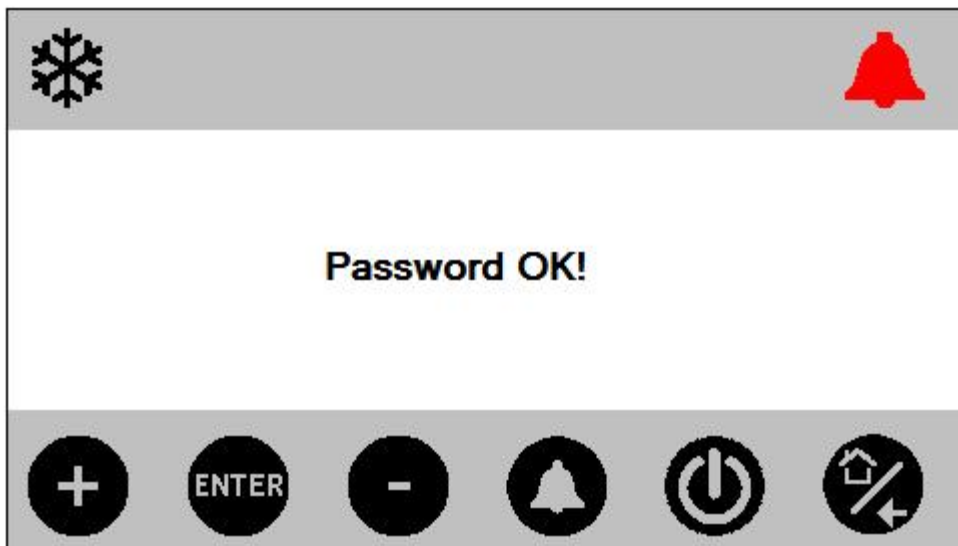
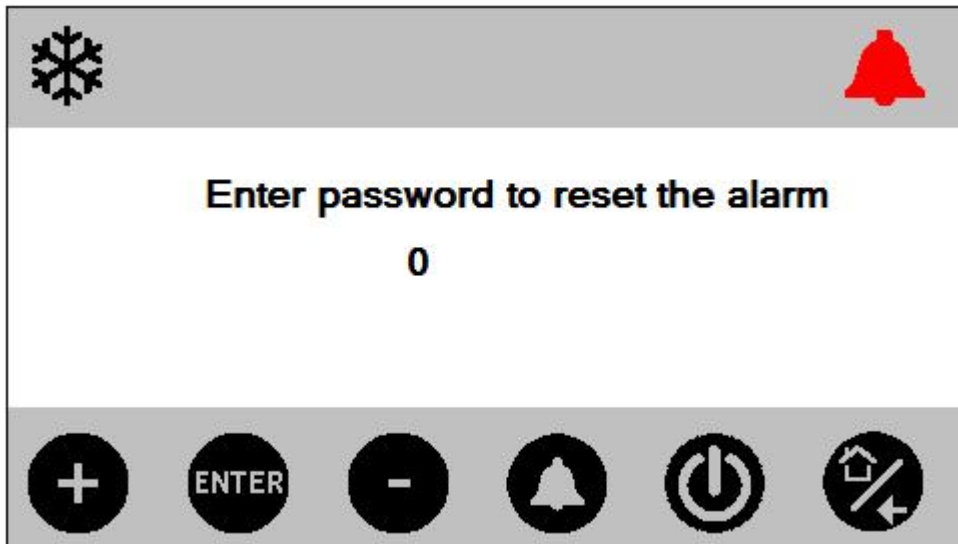

- How to reset the alarm log:
- Tap on RST ALL
  - Tap ENTER button
  - Use + and – to type the password value
  - Tap ENTER button





- **DEFROST menu**   
DEFROST menu allows to display the defrost status of the gas circuits.  
Click directly on **Circuit 1** or **Circuit 2** to enter to the specific circuit.

 **Defrost main menu**



**Circuit 1** drip time in progress

**Circuit 2** cycle not in progress

 



 **Circuit 1 cycle in progress**

Time to start (mm:ss)	0		
Condenser 1 probe	8.2	bar	
Evaporator 1 probe	N.C.		
Defrost start set	6.0	bar	
Real defrost set point	6.5	bar	

  

 **Circuit 1 cycle in progress**

Defrost end set	17.0 bar	
Combined defrost probe	2.0 °C	
Combined defrost start set	1.0 °C	
Combined defrost end set	22.0 °C	



  

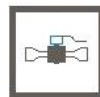

○ **SOLENOID VALVES menu**



Solenoid valves menu allows to display the status of the solenoid valves liquid line and solenoid valves of water side.

 **Solenoid valves**

Liquid solenoid valves	Solenoid valve water circuit
SV1 	SV1 
SV2 Not configured	SV2 Not configured

○ **I/O menu**





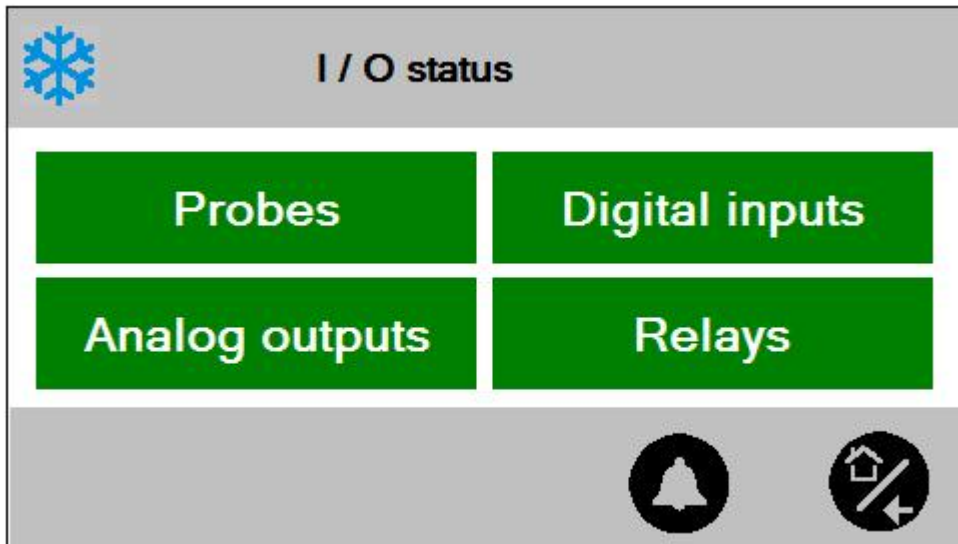

I/O menu allows to display (not modify) the status of inputs and outputs. Tap “Probes” or “Digital inputs” or “Analog outputs” or “Relays” to display the status of each resource.

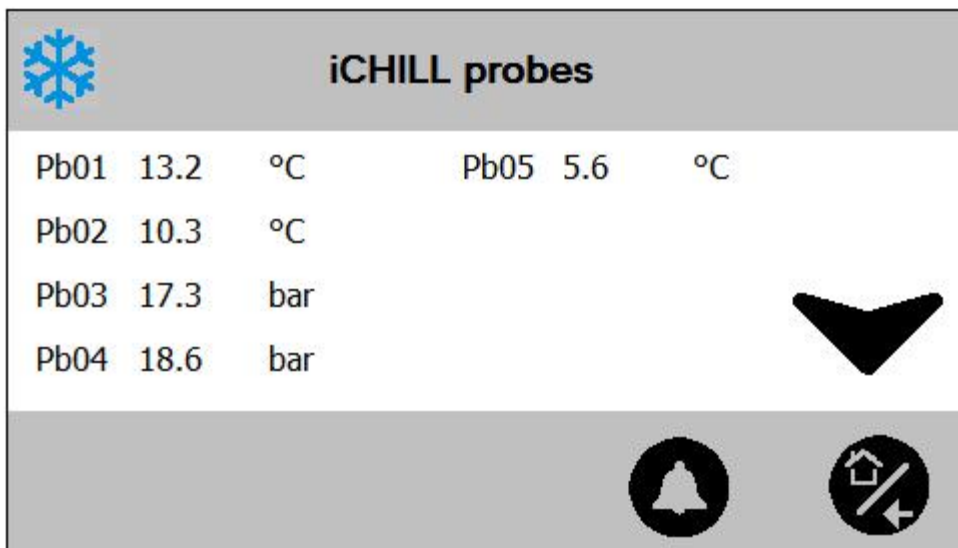



- Probes sub-menu



 <b>Expansion valve probes</b>				
<b>1</b>	PbV1	8.6	°C	
	PbV3	4.5	bar	
<b>2</b>	PbV2	6.2	°C	
	PbV4	3.4	bar	
 				

- **Analog output sub-menu**



 <b>Analog outputs</b>				
iCHiLL Analog outputs			I/O Expansion Analog Outputs	
AO01	80	%	AO01	22 %
AO02	53	%	AO02	N.C.
AO03	N.C.		AO03	N.C.
AO04	N.C.			
 				

- **Digital input sub-menu**

 **iCHILL: Digital input status**

DI01	Open	DI06	Open	DI11	Open
DI02	Closed	DI07	Closed		
DI03	Open	DI08	N.C.		
DI04	Open	DI09	N.C.		
DI05	N.C.	DI10	N.C.		





 **I/O Expansion: Digital input status**

DI01	N.C.1	DI05	N.C.1	DI09	N.C.1
DI02	N.C.1	DI06	N.C.1		
DI03	N.C.1	DI07	N.C.1		
DI04	N.C.1	DI08	N.C.1		





 

- **Digital output sub-menu**



 **iCHILL: Relay status**

RL01	ON	RL05	ON	
RL02	OFF	RL06	OFF	
RL03	ON	RL07	OFF	
RL04	N.C.	RL08	N.C.	

 

 **I/O Expansion: Relay status**

RL01	OFF	RL05	OFF	
RL02	ON	RL06	ON	
RL03	OFF	RL07	OFF	
RL04	OFF			

 

- **IEV valves menu**  IEV valves menu allows to display the status of the electronic expansion valves (temperatures, set point, superheating, opening percentage).

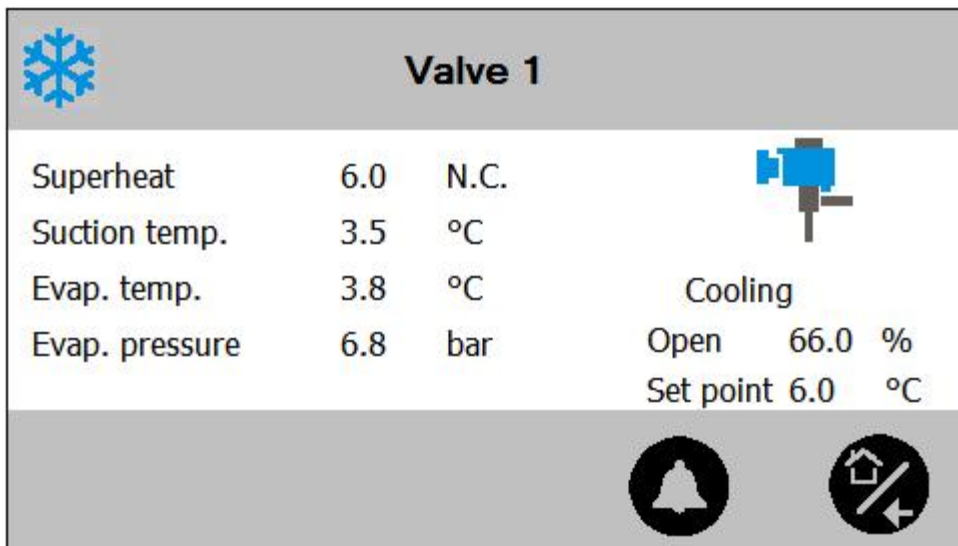
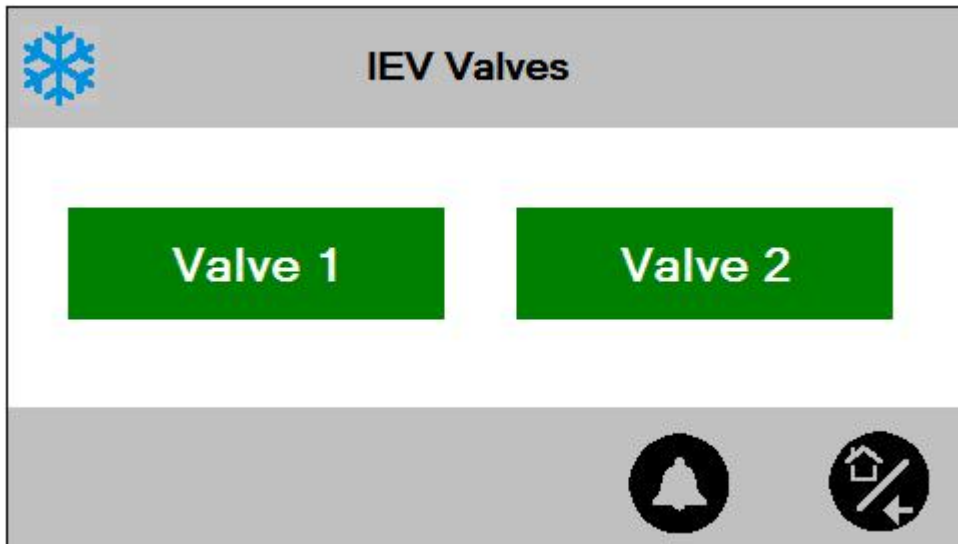

- **HEAT RECOVERY** menu 





Heat recovery menu allows to display the temperature, the set point and the valves

status; through  it is possible to disable the heat recovery.

 **Recovery enabled**

Recovery Probe	25.6 °C	<b>Rec. Valves</b>
Recovery Set Point	30.0 °C	Circuit 1 ON
		Circuit 2 OFF

Fun : 2 separate hydraulic circuits



   

- **AUXILIARY OUTPUT and HEATER menu**  Auxiliary output and heater menu allows to display the status of the auxiliary outputs (temperatures, set point, output status) and the antifreeze heaters and boiler heaters status.

 **Auxiliary output / Heaters**

**Auxiliary output**

**Heaters**





**Auxiliary output**

**Auxiliary relay 1**

**Auxiliary relay 2**

**Prop. Output AUX 1**

**Prop. Output AUX 2**





**AUX relays status**



**Auxiliary relay 1**

<b>Output status</b>	<b>OFF</b>
Auxiliary relay 1 probe selection	25.6 °C
Auxiliary relay 1 summer set point	22.0 °C
Auxiliary relay 1 winter set point	18.0 °C



**Analog outputs status**



### Prop. Output AUX 1

**Output value : 68 %**



Aux. Proportional Output 1 probe	25.4 °C
Analog output 1 summer set point	22.0 °C
Analog output 1 winter set point	18.0 °C





### Antifreeze heaters and boiler heaters



### Antifreeze/Boiler Heaters

Evaporator Antifreeze Heaters		OFF
Condenser Antifreeze Heaters		OFF
Heating/Boiler Heaters	N.C.	N.C.











○ **FREE COOLING AND SOLAR PANEL menu**

Free cooling and solar panel menu allows to display:



- Free cooling status (temperatures, set point, valve status)
- Solar panel status (temperatures, set point, valve status)



 **Free cooling Active**

Free cooling temp. 1	22.6	°C		
Free cooling temp. 2	17.6	°C		
Free cooling set point	19.0	°C		
Differential to enable FC	4.0	°C		

 

 **Solar panel: Active**



Sanitary water temp.	37.8	°C		
Solar panel set point	75.0	°C		
Solar panel temp	85.6	°C		

 



- **DISCHARGE COMPRESSOR menu**  Discharge compressor menu allows to display compressor discharge temperature, liquid injection valve set point, and the status of liquid injection valve.



 **Discharge compressor**

	<b>Set</b>	<b>Diff.</b>	
Disch. temp. alarm	120.0 °C	30.0 °C	
Liquid inject. set	110.0 °C	20.0 °C	

 



 **Compressors circ. 1**





	<b>Comp. 1</b>	
Discharge temp	85.0 °C	 
Liquid injection valve	OFF	
Min. load start-up valve	OFF	

 

- **DOMESTIC HOT WATER menu**  Domestic hot water menu allow to display the status of domestic hot water circuit (temperatures, set point, valves and water pumps status) and the status of antilegionella cycle (set point, day of activation, remaining time to next anti-legionella cycle).



 **Sanitary water: in progress**

Sanitary water temp.	37.0 °C	
Sanitary water set point	42.0 °C	
Real san. water set point	45.0 °C	V1 
Sanitary secur. temp.	39.5 °C	
Security set point	55.0 °C	

    

 **Antilegionella cycle: enabled - not in progress**

Sanitary water temp.	37.0 °C	
Antilegionella set point	60.0 °C	
Enabled:every: Thursday	Hou22 :00r	<b>Last cycle</b>
Time to start cycle:	6 :42 Hour	<b>Not completed</b>

- **SETTING menu** 

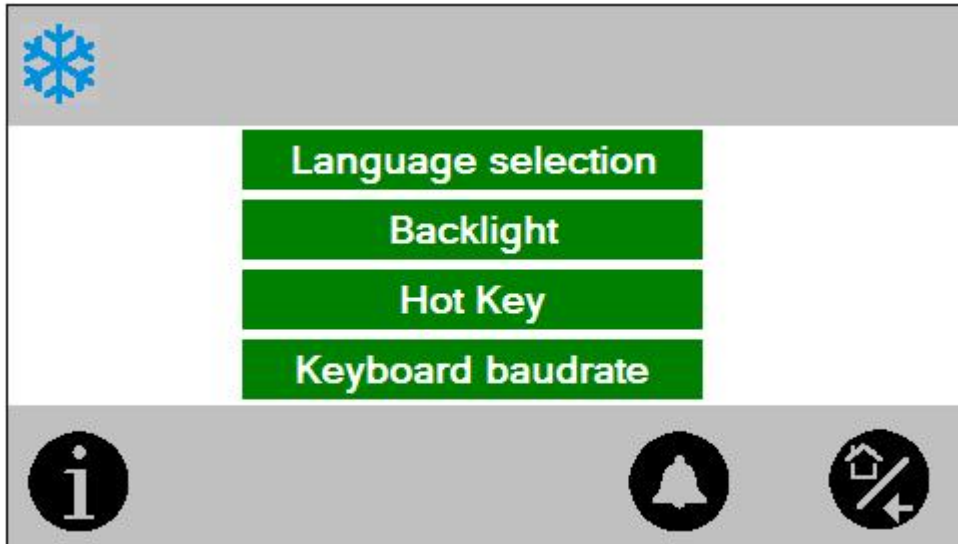

### Language selection.

Language selection menu allows to choose the language; tap on the language to select it.



### Back-light time.

How to modify the back-light time:

- Tap Set button
- Use + and – to modify the value
- Tap Set button to confirm

Back-light time is expressed on minutes; if the touch panel is not touched for "x" minutes, the brightness is reduced (not switched off).

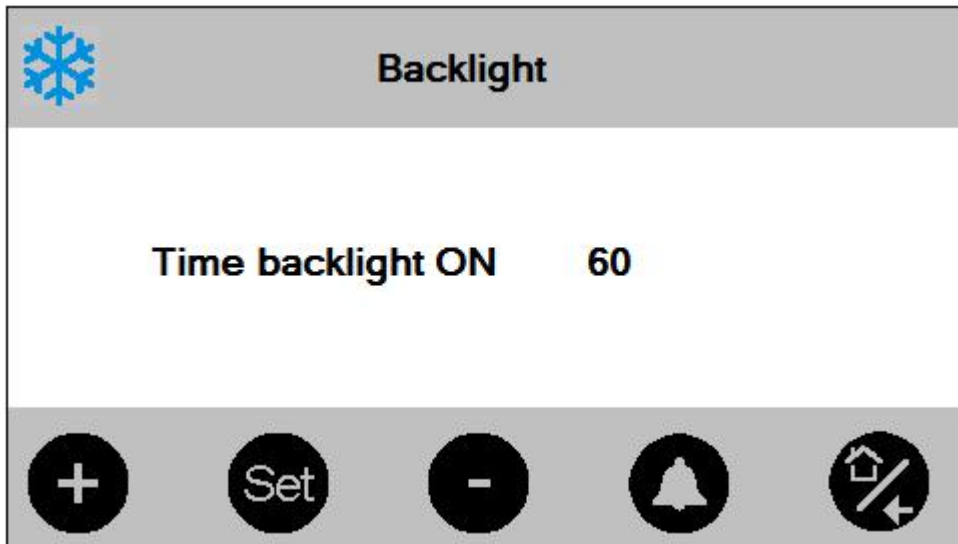

### HotKey

Hot key menu allows to:

- Copy the parameters map from Ichill to HotKey64 (Upload)
- Copy the parameters map from HotKey64 to the Ichill (Download); this operation is allowed only if the Ichill is in remote OFF or STD-BY.

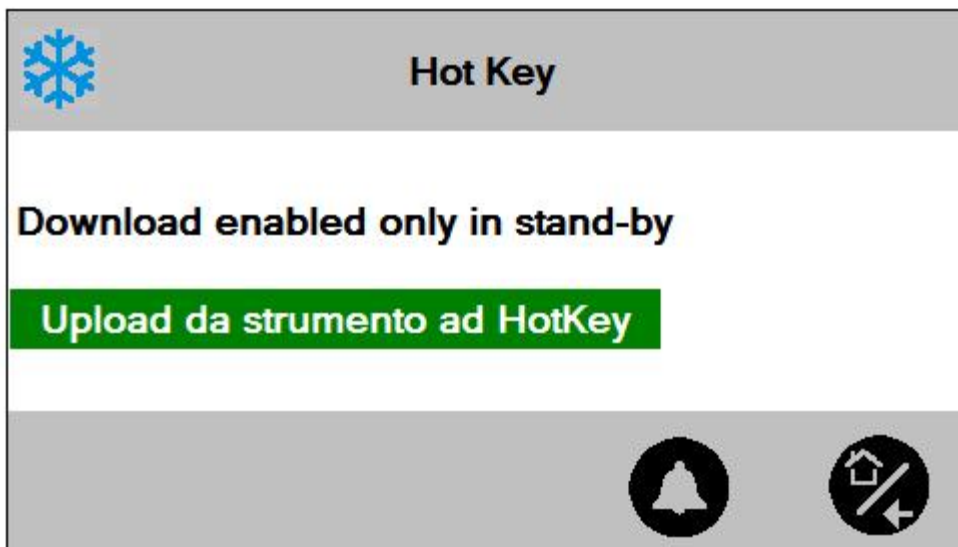





### Baud-rate

Don't modify the baud-rate; the Visotouch is already set with the right baud-rate. Changing the baud-rate result in the loss of communication with the Ichill.

 **Keyboard Baudrate**

**Baudrate**      **19200**

Unplug and reconnect the Visotouch  
to confirm the Baudrate changing

**System information** 



 **System information**

**iCHILL200 firmware release 43**

**Keyboard firmware release 2.32**

**Keyboard bin release 4.3**

**Date keyboard bin 27/01/2017**

**Dixell**  **EMERSON**  
Climate Technologies

**Dixell S.r.l.** - Z.I. Via dell'Industria, 27 - 32010 Pieve d'Alpago (BL) ITALY  
Tel. +39.0437.9833 r.a. - Fax +39.0437.989313 - EmersonClimate.com/Dixell - dixell@emerson.com